

Data sheet | Item number: 286-662

Current flow monitoring module; DC current flow monitoring module; 0.4 A ...
3.5 A; Relay with 1 make contact (1a)

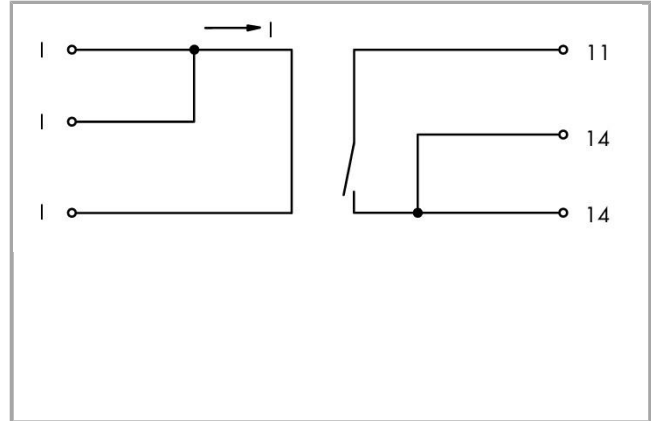

286-662



RoHS Compliant

[BOMcheck.net](https://www.bomcheck.net)

Color:

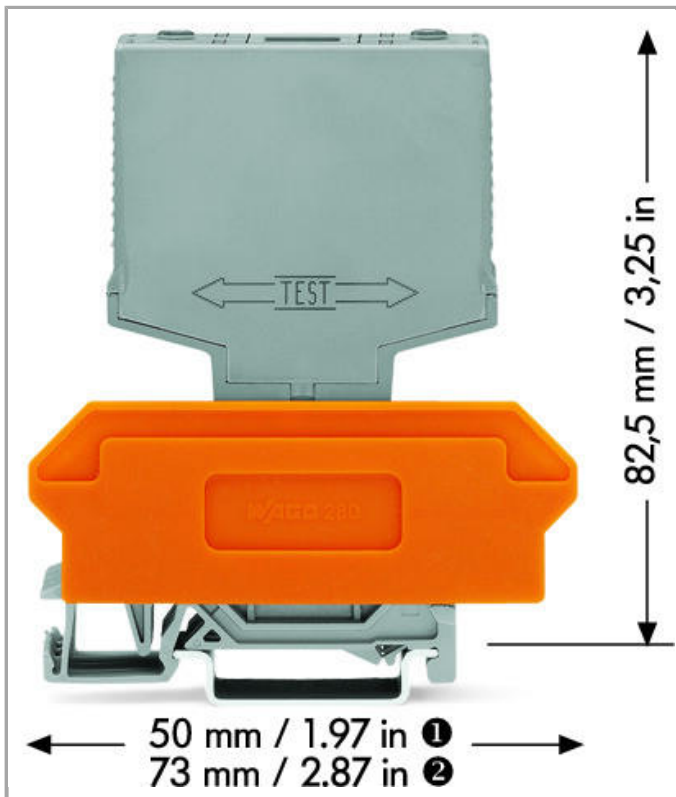

Data

Electrical data

Operating voltage	DC 12 ... 28 V
Current consumption at supply voltage	0
Voltage drop at input	24 ... 210 mV
Max. measuring span	0.4 ... 3.5 ADC (-20 ... +40 °C); 0.4 ... 3 ADC (-20 ... +60 °C); 0.4 ... 2 ADC (-20 ... +70 °C)
Turn on / off point	0.35 A / 0.07 A
Response time	0.5ms
Number of make contacts/switch on contacts	1
Limiting continuous current	0.5 A
Max. switching voltage	DC 200 V
Max. switching power (resistive)	DC 10 W

Safety and protection:

Dielectric strength input/output (AC, 1 min)	1.5 kVrms
--	-----------

Mechanical data

Type of mounting	Pluggable module for carrier terminal blocks
Housing design	Pluggable module for terminal blocks

Material Data

Color	light gray
Fire load	0 MJ
Weight	22.7

Environmental Requirements









Surrounding air (operating) temperature	-25 ... 40 °C
---	---------------

Commercial data

Product Group	6 (Interface Electronics)
Country of origin	DE
GTIN	4045454415730
Customs Tariff No.	85364900990

Compatible products

Marking accessories

	Item no.: 209-701 WSB marking card; as card; not stretchable; plain; snap-on type		209-701
	Item no.: 209-701/000-002 WSB marking card; as card; not stretchable; plain; snap-on type	/000-002	209-701
	Item no.: 209-701/000-005 WSB marking card; as card; not stretchable; plain; snap-on type	/000-005	209-701
	Item no.: 209-701/000-006 WSB marking card; as card; not stretchable; plain; snap-on type	/000-006	209-701
	Item no.: 209-701/000-007 WSB marking card; as card; not stretchable; plain; snap-on type	/000-007	209-701
	Item no.: 209-701/000-012 WSB marking card; as card; not stretchable; plain; snap-on type	/000-012	209-701
	Item no.: 209-701/000-017 WSB marking card; as card; not stretchable; plain; snap-on type	/000-017	209-701
	Item no.: 209-701/000-023 WSB marking card; as card; not stretchable; plain; snap-on type	/000-023	209-701



Item no.: 209-701/000-024
WSB marking card; as card; not stretchable; plain; snap-on type

209-701

/000-024

General accessories

Item no.: 280-609
Terminal block for pluggable modules; 12-pole; with 4-conductor terminal blocks; with orange separator; for DIN-rail 35 x 15 and 35 x 7.5; 2.5 mm²; CAGE CLAMP®

280-609



Item no.: 280-619
Terminal block for pluggable modules; 6-pole; with 2-conductor terminal blocks; with orange separator; for DIN-rail 35 x 15 and 35 x 7.5; 2.5 mm²; CAGE CLAMP®

280-619



Item no.: 280-763
Terminal block for pluggable modules; 12-pole; with 4-conductor terminal blocks; with marker carrier; with orange separator; for DIN-rail 35 x 15 and 35 x 7.5; 2.5 mm²; CAGE CLAMP®

280-763

Downloads
Documentation**Bid Text**

286-662	Jan 15, 2016	doc 24.6 kB	Download
Interface-Bausteine mit Sonderfunktionen			

Additional Information

Disposal; Electrical and electronic equipment, Packaging	V 1.0.0	pdf 265.8 kB	Download
--	---------	-----------------	----------

Subject to changes.